

„Internet“ Measurement

The “Internet”: Challenges

- ❑ Explosive growth and moving target
- ❑ Heterogeneity any which way you look
- ❑ New requirements: security, reliability, ...
- ❑ Complex user behavior and traffic dynamics
- ❑ Designed as open, cooperating, static system
- ❑ **Highly interacting systems**
 - **Temporal:** between users, hosts and networks
 - **Spatial:** among different components
 - **Vertical:** across different networking layers

Scenarios To Be Addressed

Example 1:

- Situation: network connectivity fails
- Presumed action: call system administrator
- Effect: no phone call possible
- Why: telephone service via VoIP

Example 2:

- Situation: remote computer/router fails
- Presumed action: connect to device via control net.
- Effect: no connection
- Why: no reliable backup network

The “Network”: Advantages

- Highly engineered structure
 - Well specified and documented
- Unique measurement capabilities
 - In theory unlimited access to data :-)
- Exploiting available data
 - Learn from the existing artifact
 - Use invariants and structural models not details
 - Consider emerging phenomena
 - Use network wide data

Challenges

The total is more than the sum of its pieces

- Specify and manage **services** rather than **components**
- Address the gap in understanding between **individual pieces** and the **overall**

Internet: A Complex Layered Distributed System

- ❑ Physical connectivity: Links
- ❑ Point-to-point connectivity: NIC, switches
 - distributed hardware, protocols – local management
- ❑ End-to-end connectivity: Routers
 - Forwarding, addressing, routing
 - Distributed hardware, protocols, software, management by Internet Service Providers (ISPs)
- ❑ Process-to-process connectivity: TCP, UDP
 - De-/multiplexing, reliability, congestion control, ...
- ❑ Applications: Web, P2P, ...
 - Users
 - Distributed, independent, autonomous, ...

Tools

❑ Instrumentation and analysis

- Integrate measurements into the design process
- Collect data at a variety of different locations/levels
- Find invariants and correlate various datasets

❑ Simulation

- Build a mirror world for "what if" studies
- Verify explanations

❑ Test-Labs

- Incorporate variability
- Provide an friendly/unfriendly environment

Measurement Analysis

- Interesting when combining multiple datasets
 - Same data different locations
 - Root cause analysis of BGP events
 - Internet topology derivation
 - ...
 - Different data sets
 - Intra-domain traffic matrix
 - Inter-domain traffic matrix
 - ...

Terminology And General Issues

- ❑ **Measurements vs. metrics**
- ❑ Measurement capabilities
- ❑ Collection of measurement data
- ❑ Data reduction techniques
- ❑ Clock issues

Terminology: Measurements vs. Metrics

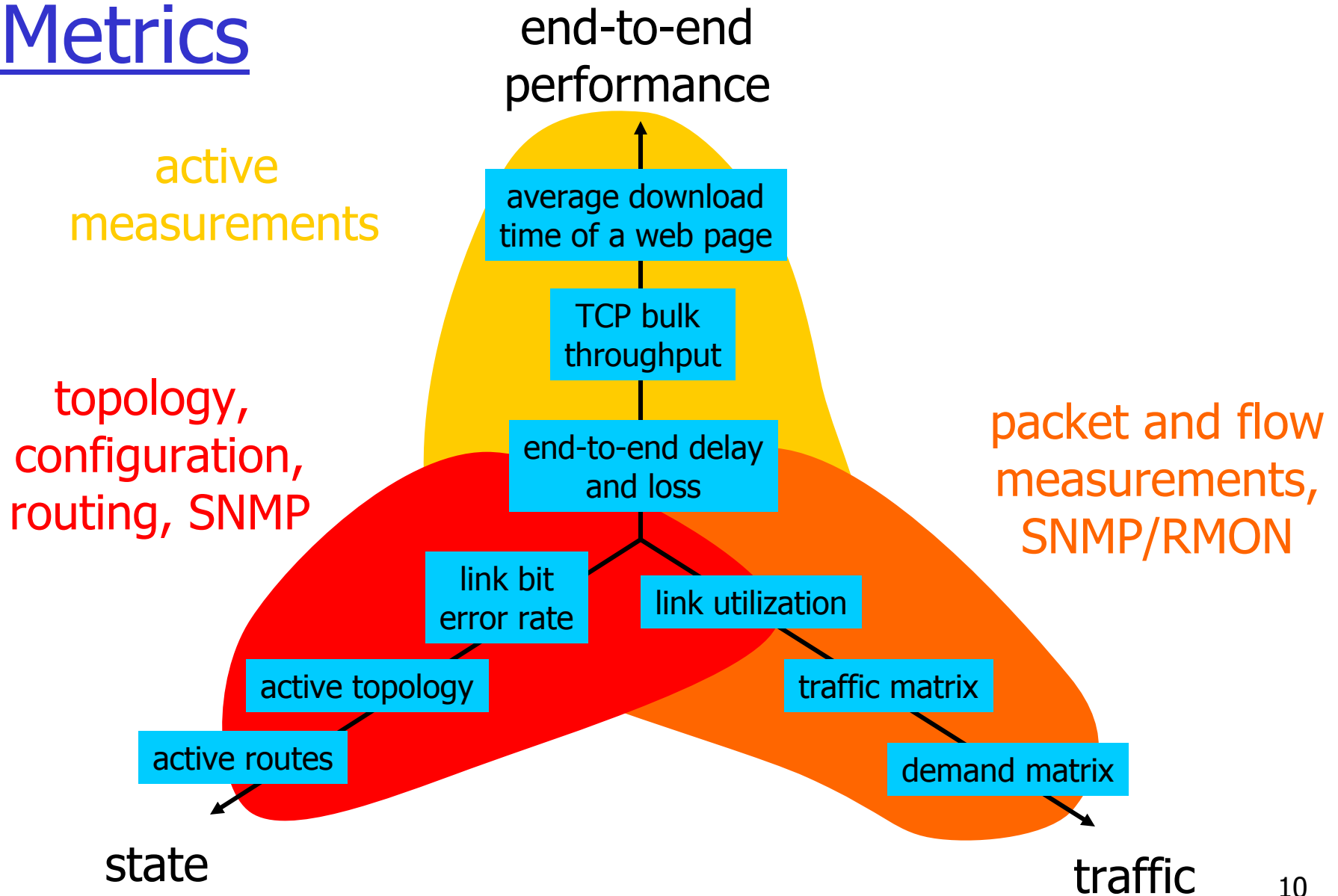

Terminology And General Issues

- ❑ Measurements vs. metrics
- ❑ **Measurement capabilities**
- ❑ Collection of measurement data
- ❑ Data reduction techniques
- ❑ Clock issues

Active Measurements

□ Definition:

- Injecting measurement traffic into the network
- Computing metrics on the received traffic

□ Scope

- Closest to end-user experience
- Least tightly coupled with infrastructure
- Comes first in the detection/diagnosis/correction loop

Passive Measurements

□ Definition:

- Observing traffic into the network
- Computing metrics on the monitored traffic

□ Scope

- Closest to network
- Tightly coupled with infrastructure

Passive Measurement Capabilities: Packet Monitors

- Available data:
 - All protocol information
 - All content

Monitoring A LAN Link

Shared media (Ethernet, wireless)

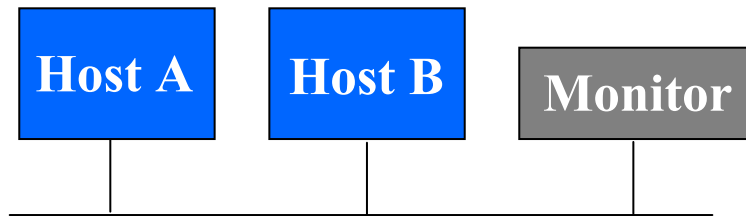

Monitor integrated with a bridge

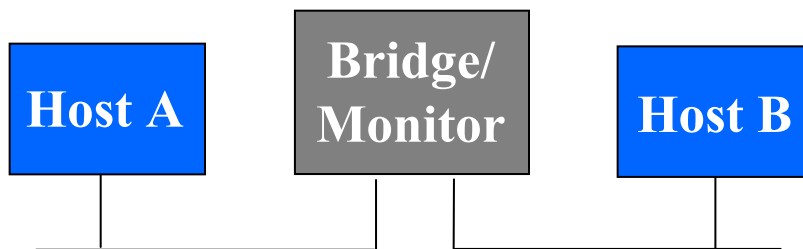

Multicast switch

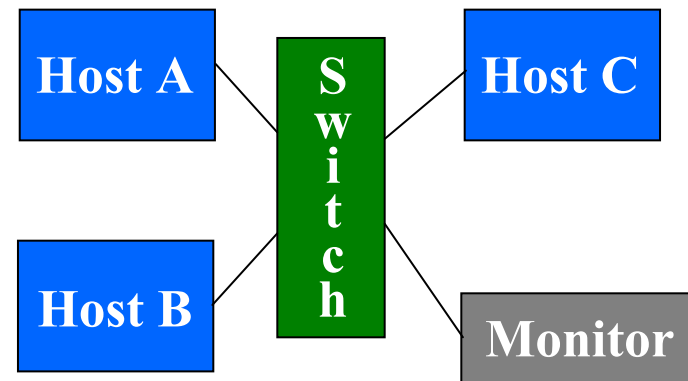

Monitoring A WAN Link

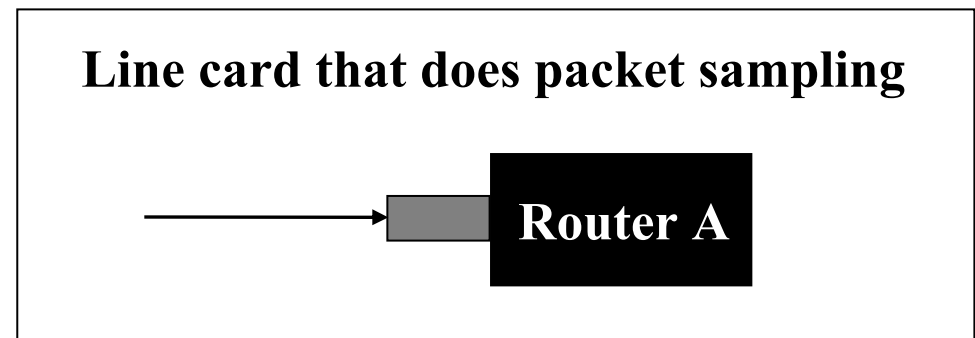
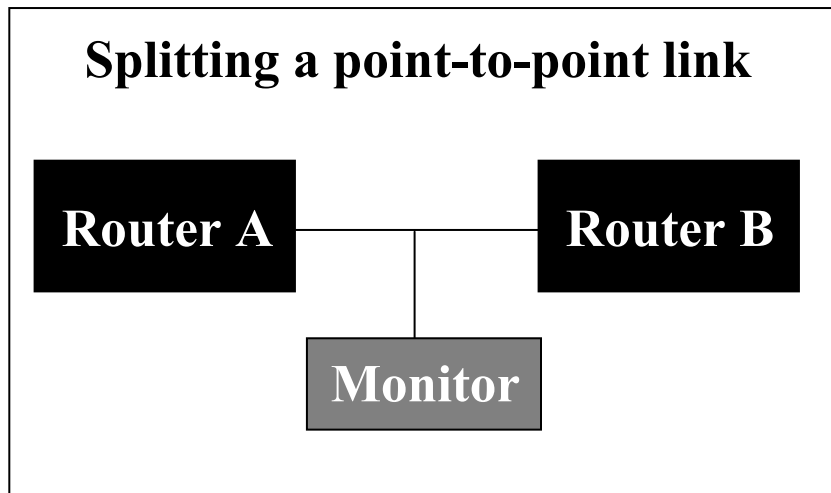

Passive Measurement Capabilities: Packet Monitors (2.)

- ❑ Available data:
 - All protocol information
 - All content
- ❑ Possible analysis:
 - Application performance
 - User behavior (search engine comparisons)
 - Application usage (P2P usage)
 - Abuse detection (intrusion detection system)
- ❑ Disadvantages:
 - Data flood
 - Data aggregation
 - Needle in a haystack
 - Only captures on network information (no device info)
 - Usually needs fixed installations

Selecting Traffic

- ❑ Filter to focus on a subset of the packets
 - IP addresses/prefixes (e.g., to/from specific Web sites, client machines, DNS servers, mail servers)
 - Protocol (e.g., TCP, UDP, or ICMP)
 - Port numbers (e.g., HTTP, DNS, BGP, Napster)
- ❑ Collect first n bytes of packet (snap length)
 - Medium access control header (if present)
 - IP header (typically 20 bytes)
 - IP+UDP header (typically 28 bytes)
 - IP+TCP header (typically 40 bytes)
 - Application-layer message (entire packet)

IP Header Format

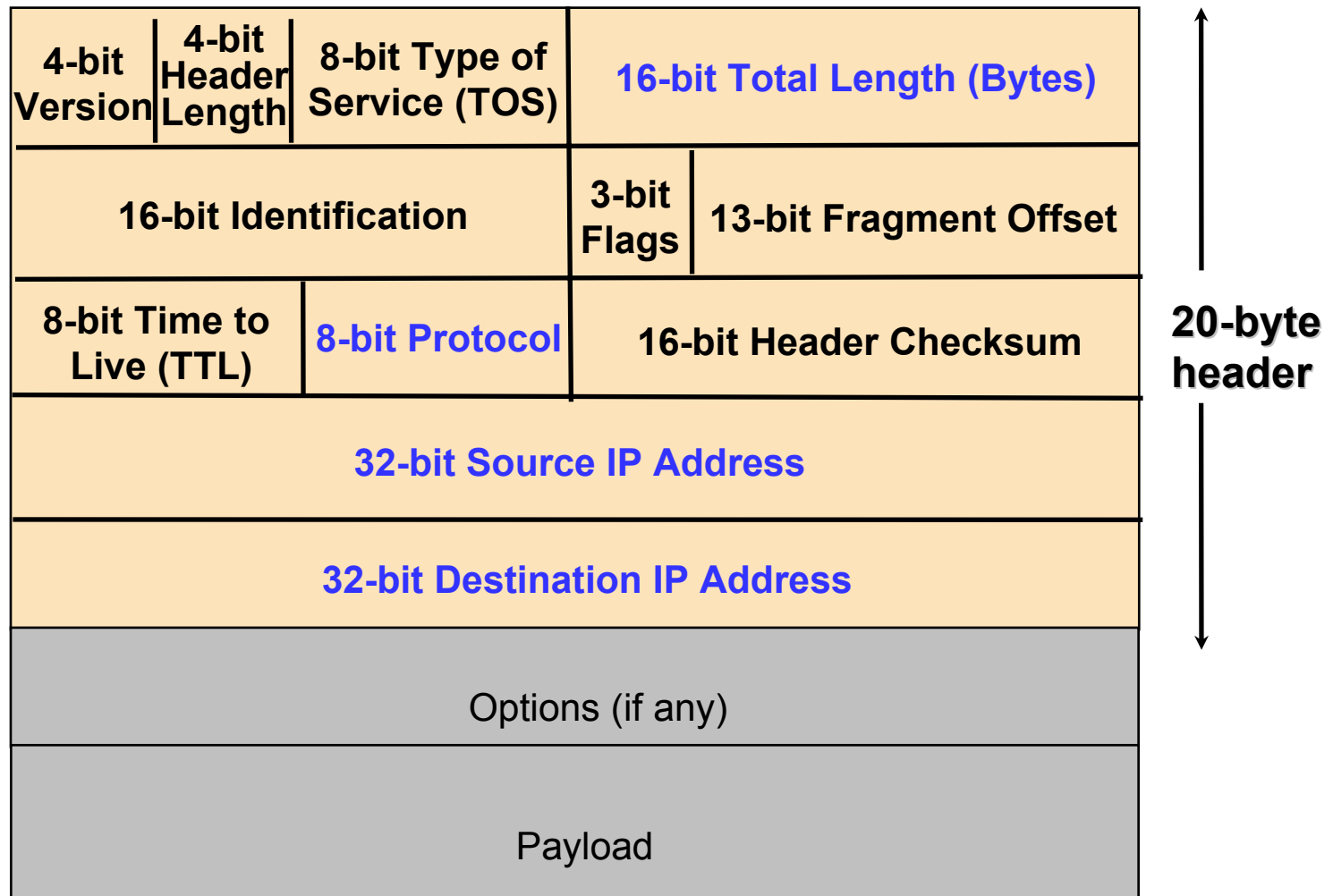

Analysis Of IP Header Traces

- ❑ Source/destination addresses for traffic
 - Identity of popular Web servers & heavy customers
- ❑ Traffic breakdown by protocol (TCP/UDP/ICMP)
 - Amount of traffic not using congestion control
- ❑ Distribution of packet delay through the router
 - Identification of typical delays and anomalies
- ❑ Distribution of packet sizes
 - Workload models for routers and measurement devices
- ❑ Burstiness of the traffic on the link over time
 - Provisioning rules for allocating link capacity
- ❑ Throughput between each pair of src/dest addresses
 - Detection and diagnosis of performance problems

TCP header format

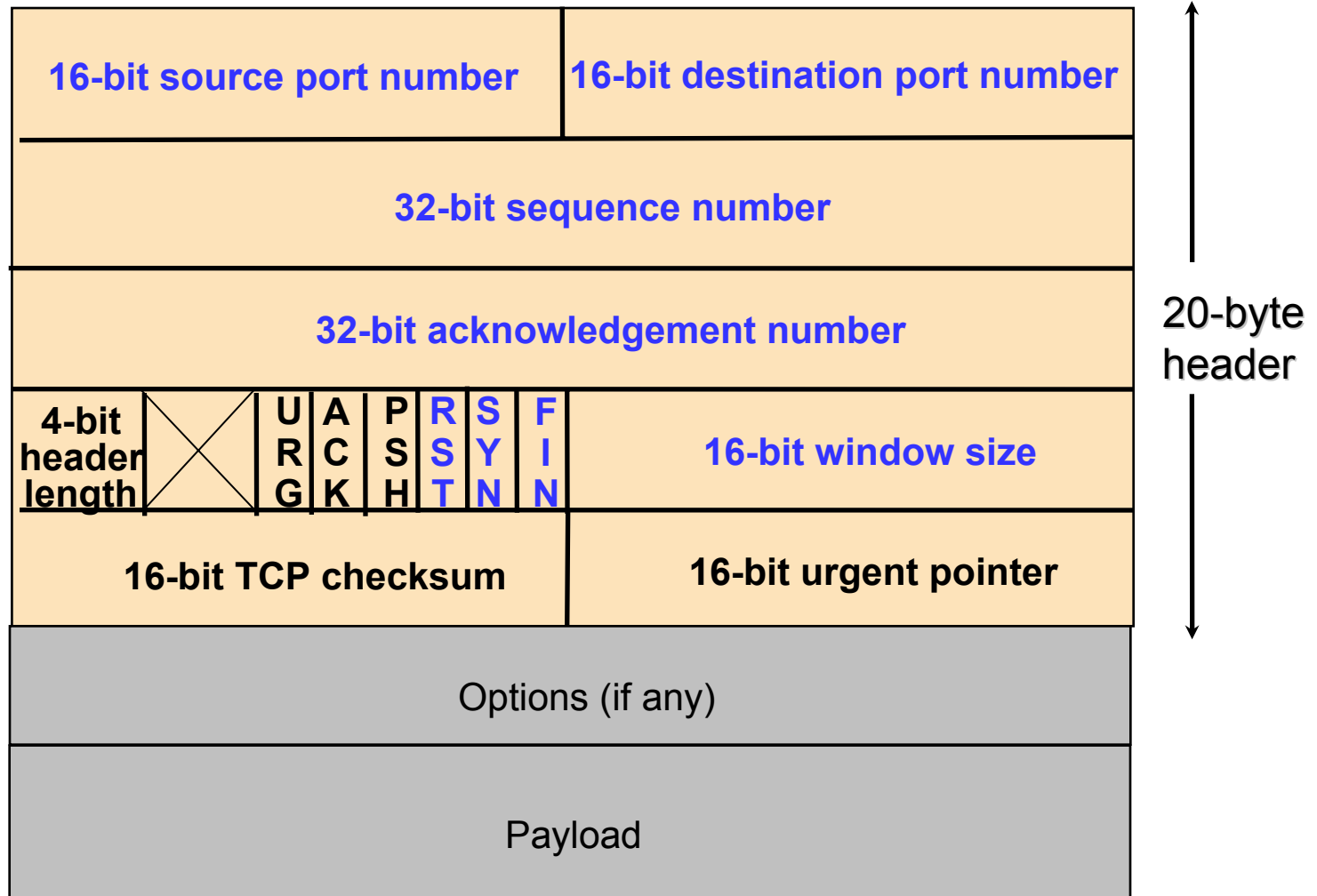

Tcpdump Output

(three-way TCP handshake and HTTP request message)

23:40:21.008043 eth0 > 135.207.38.125.1043 > lovelace.acm.org.www: S
617756405:617756405 (0) win 32120 <mss 1460,sackOK,timestamp 46339
0,nop,wscale 0> (DF)

23:40:21.036758 eth0 < lovelace.acm.org.www > 135.207.38.125.1043: S
2598794605:2598794605 (0) **ack** 617756406 win 16384 <mss 512>

23:40:21.036789 eth0 > 135.207.38.125.1043 > lovelace.acm.org.www: .
1:1(0) ack 1 win 32120 (DF)

23:40:21.037372 eth0 > 135.207.38.125.1043 > lovelace.acm.org.www: P
1:513(512) ack 1 win 32256 (DF)

23:40:21.085106 eth0 < lovelace.acm.org.www > 135.207.38.125.1043: .
1:1(0) **ack** 513 win 16384

23:40:21.085140 eth0 > 135.207.38.125.1043 > lovelace.acm.org.www: P
513:676(163) ack 1 win 32256 (DF)

23:40:21.124835 eth0 < lovelace.acm.org.www > 135.207.38.125.1043: P
1:179(178) **ack** 676 win 16384

TCP Header Analysis

- ❑ Source and destination port numbers
 - Popular applications (HTTP, Napster, SMTP, DNS)
 - Number of parallel connections between source-dest pairs
- ❑ Sequence/ACK numbers and packet timestamps
 - Out-of-order/lost packets; violations of congestion control
 - Estimates of throughput and delay of Web downloads
- ❑ Number of packets/bytes per connection
 - Size of typical Web transfers; frequency of bulk transfers
- ❑ SYN flags from client machines
 - Unsuccessful connection requests; denial-of-service attacks
- ❑ FIN/RST flags from client machines
 - Frequency of Web transfers aborted by clients

Packet Contents

- ❑ Application-layer header
 - HTTP and RTSP request and response headers
 - FTP, NNTP, and SMTP commands and replies
 - DNS queries and responses; OSPF/BGP messages
- ❑ Application-layer body
 - HTTP resources (or checksums of the contents)
 - User keystrokes in Telnet/Rlogin sessions
- ❑ Security/privacy
 - Significant risk of violating user privacy
 - More sensitive for information from higher-level protocols
 - Traffic analysis thwarted by use of end-to-end encryption

HTTP Request And Response Message

```
GET /tutorial.html HTTP/1.1
Date: Mon, 27 Aug 2001 08:09:01 GMT
From: jrex@research.att.com
User-Agent: Mozilla/4.03
CRLF
```

Request

Response

```
HTTP/1.1 200 OK
Date: Thu, 12 Jul 2001 10:09:03 GMT
Server: Netscape-Enterprise/3.5.1
Last-Modified: Sun, 12 Mar 2000 11:12:23 GMT
Content-Length: 23
CRLF
Traffic measurement talk
```

Application-layer Analysis

- ❑ URLs from HTTP request messages
 - Popular resources/sites; potential benefits of caching
- ❑ Meta-data in HTTP request/response messages
 - Content type, cacheability, change frequency, etc.
 - Browsers, protocol versions, protocol features, etc.
- ❑ Contents of DNS messages
 - Common queries, frequency of errors, query latency
- ❑ Contents of Telnet/Rlogin sessions
 - Intrusion detection (break-ins, stepping stones)
- ❑ Routing protocol messages
 - Workload for routers; detection of routing anomalies
 - Tracking the current topology/routes in the backbone

Mechanics: Application-level Messages

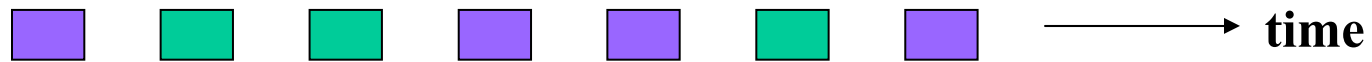

- Application-level transfer may span multiple packets
 - Demultiplex packets into separate “flows”
 - Key of source/dest IP addresses, port #s, and protocol
 - Hash table to store packets from different flows

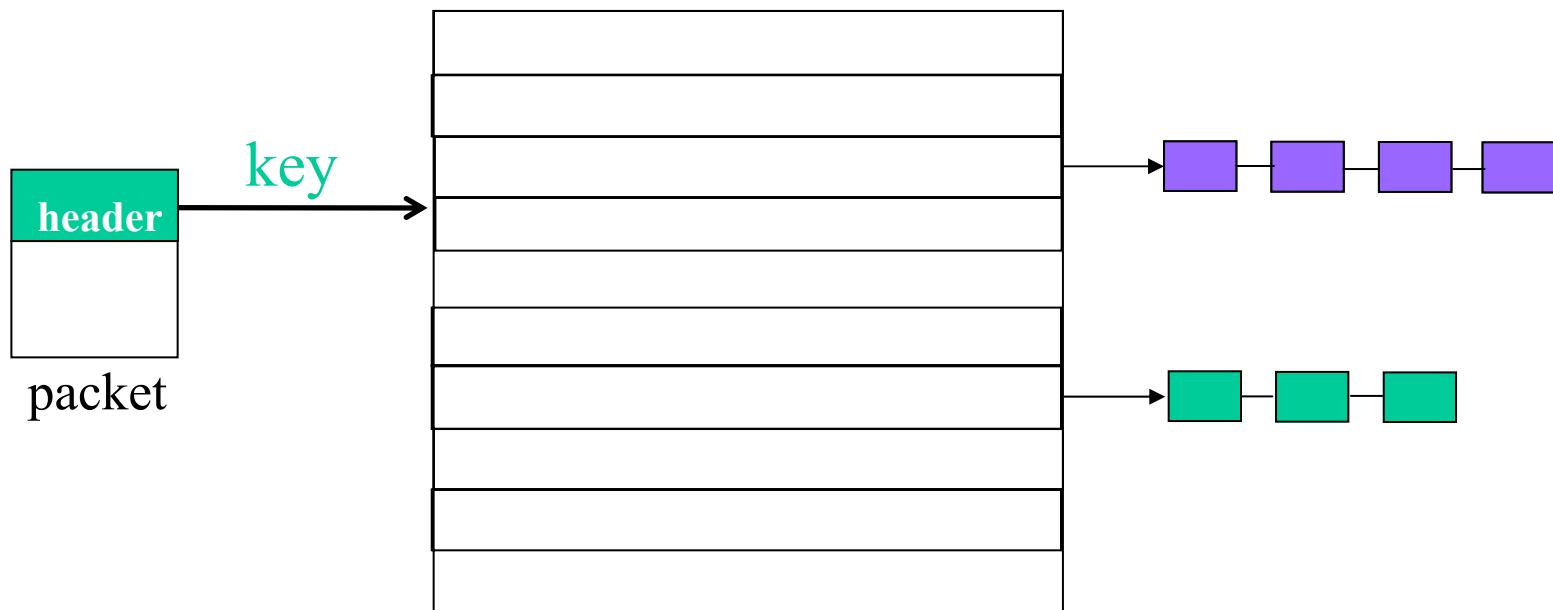

Mechanics: Application-level Messages

- ❑ Reconstructing ordered, reliable byte stream
 - Sequence number and segment length in TCP header
 - Heap to store packets in correct order & discard duplicates
- ❑ Extraction of application-level messages
 - Parsing the syntax of the application-level header
 - Identifying the start of the next message (if any)

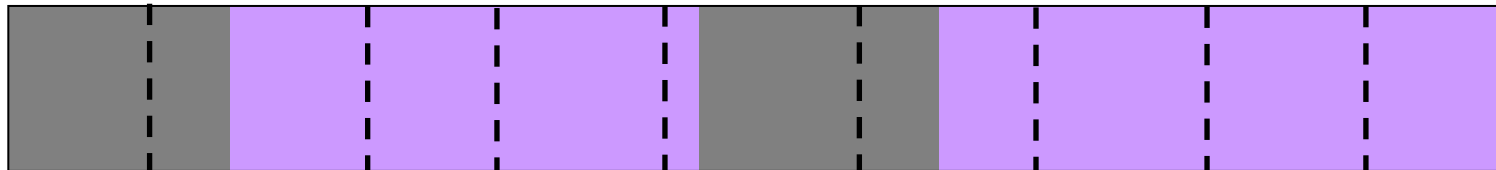

- ❑ Logging or online analysis of message
 - Record URL, header, body, checksum, timestamps, etc.
 - Copy traces or analysis result to separate machine

Placement Of The Monitor (Edge)

❑ Client edge

- Capture all traffic to/from a single group of clients
- Useful for evaluating effectiveness of a proxy
- May not be representative of other clients

❑ Server edge

- Capture all traffic to/from a set of Web sites
- Useful for detailed characterization of access patterns
- May not be representative of accesses to other sites

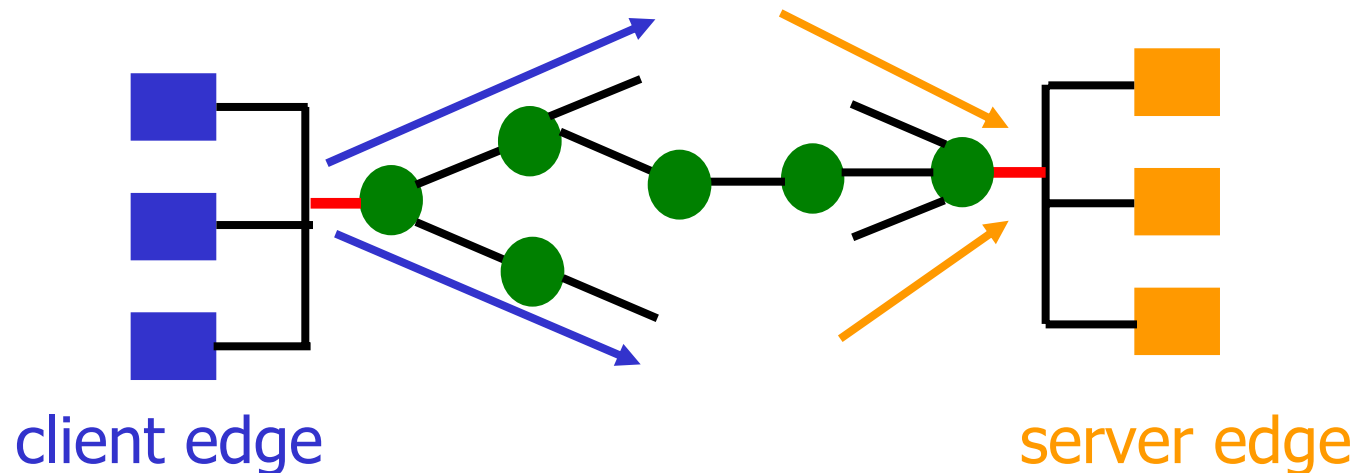

Placement Of The Monitor (Core)

□ Middle of network

- Capture all traffic traversing a particular link
- Useful for capturing a diverse mix of traffic
- May not see all traffic traveling from host A to host B
- May not see the reverse traffic from host B to host A

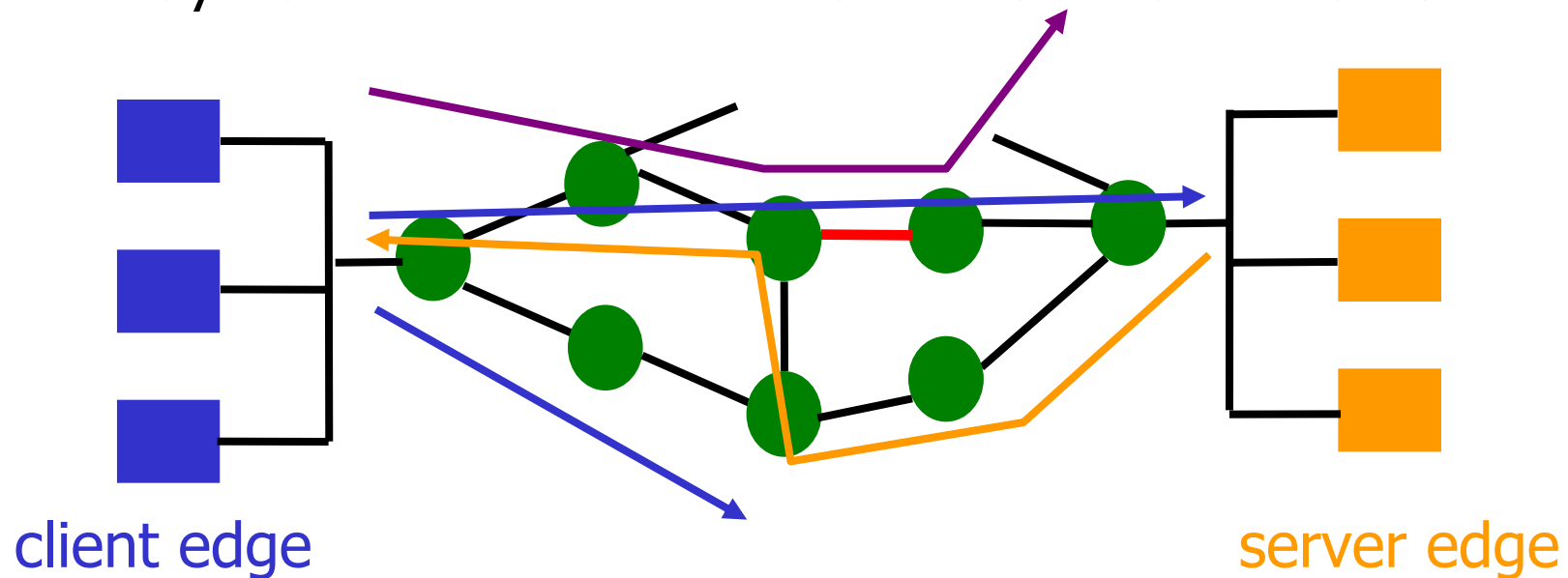

System Constraints

- ❑ High data rate
 - Bandwidth limits on CPU, I/O, memory, and disk/tape
 - Could monitor lower-speed links (near the edge of network)
- ❑ High data volume
 - Space limitations in main memory and on disk/tape
 - Could do online analysis to sample, filter, & aggregate
- ❑ High processing load
 - CPU/memory limits for extracting, counting, & analyzing
 - Could do offline processing for time-consuming analysis
- ❑ General solutions to system constraints
 - Sub-select the traffic (addresses/ports, first n bytes)
 - Kernel and interface card support for measurement
 - Efficient/robust software and hardware for the monitor

Passive Measurement Capabilities: Packet Monitors (3.)

- ❑ Deployment scenarios:
 - Needs cooperation of the network operator
 - Limited number
 - Specialized hardware/software
 - Data collection / aggregation infrastructure
- ❑ Challenges
 - Data integrity
 - Incomplete data
 - User privacy & network security
 - Data correlation
 - Data privacy vs. data sharing
 - Data filtering
 - Data collection across network confederations

Passive Measurement Capabilities: Flow Statistics

- Available data:
 - Summary information about traffic flows

IP Flows: What Is It?

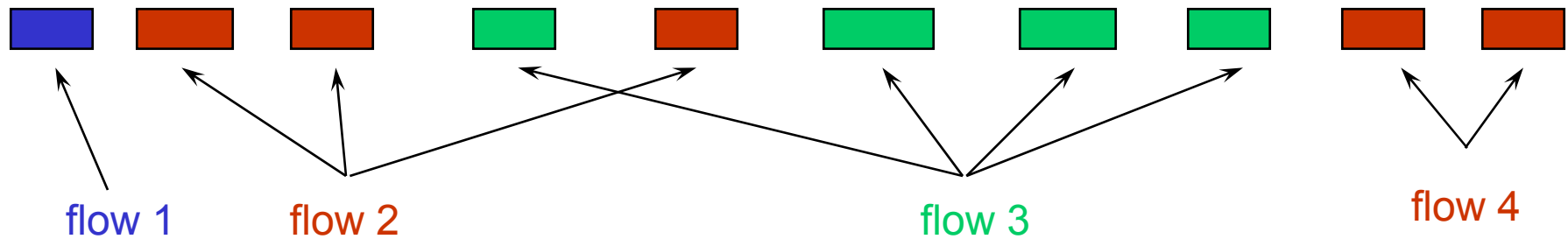

- ❑ Set of packets that “belong together”
 - Source/destination IP addresses and port numbers
 - Same protocol, ToS bits, ...
 - Same input/output interfaces at a router (if known)
- ❑ Packets that are “close” together in time
 - Maximum spacing between packets (e.g., 15 sec, 30 sec)
 - Example: flows 2 and 4 are different flows due to time

Passive measurement capabilities: Flow statistics (2.)

- ❑ Available data:
 - Summary information about traffic flows
- ❑ Possible analysis:
 - (Application performance)
 - User behavior
 - Application usage (P2P usage)
 - Abuse detection (intrusion detection system)
- ❑ Disadvantages:
 - Coarser grain information
 - Data flood
 - Data aggregation
 - Needle in a haystack
 - Only captures on network information (no device info)
 - Usually needs to be configured on network devices

Passive Measurement Capabilities: Flow Statistics (3.)

- ❑ Deployment scenarios:
 - Needs cooperation of the network operator
 - Larger number
 - Specialized hardware/software
 - Data collection/aggregation infrastructure
- ❑ Challenges
 - Lack of detail
 - Data integrity
 - Incomplete Data
 - Data correlation
 - Data privacy vs. data sharing
 - Data collection across network confederations

Passive Measurement Capabilities: SNMP/RMON statistics

- Available data:
 - Summary information from and about devices

SNMP/RMON

□ Definition:

- Standardized by IETF
- SNMP = Simple Network Management Protocol
- Definition of management information base (MIB)
- Protocol for network management system to query and effect MIB

□ Scope:

- MIB-II: aggregate traffic statistics, state information
- RMON1 (Remote MONitoring):
 - More local intelligence in agent
 - Agent monitors entire shared LAN
 - Very flexible, but complexity precludes use with high-speed links

SNMP: Naming Hierarchy And Protocol

- Information model: MIB tree
 - Naming & semantic convention between management station and agent (router)
- Protocol to access MIB
 - Get, set, get-next: nms-initiated
 - Notification: probe-initiated
 - UDP!

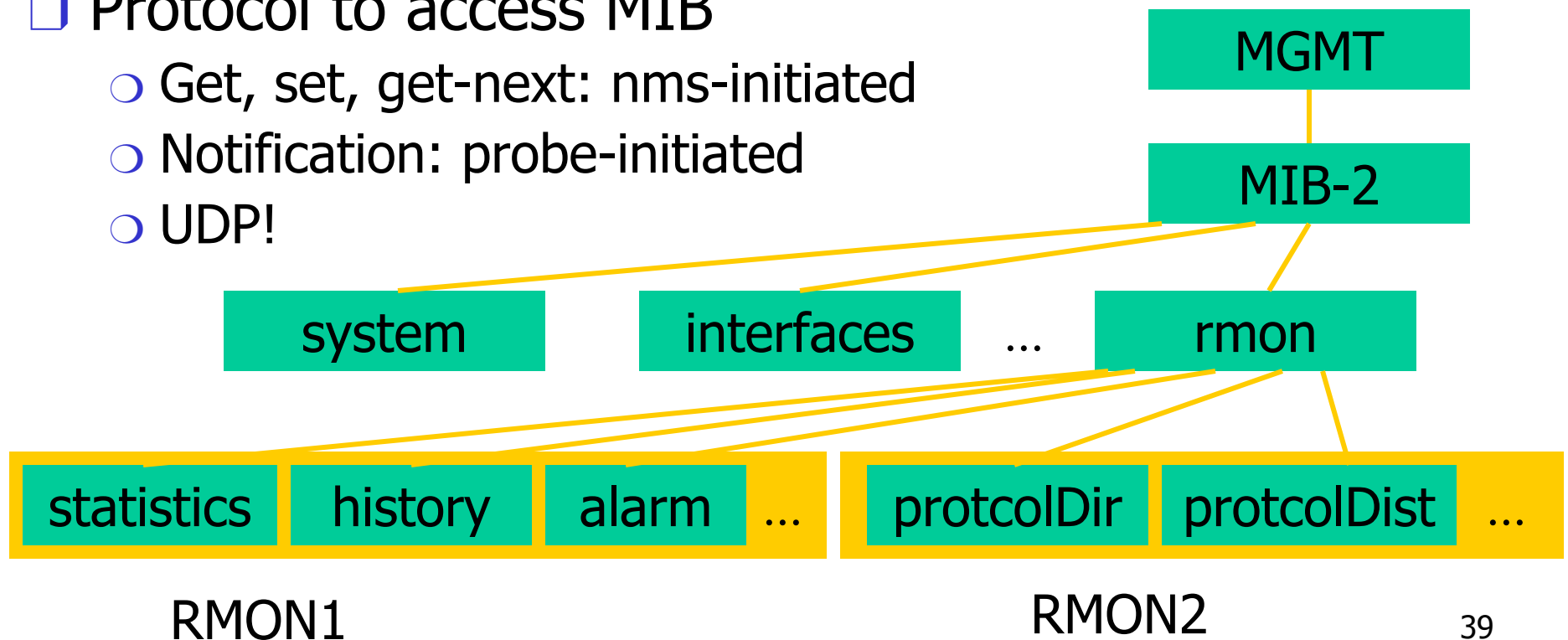

MIB-II Overview

□ Relevant groups:

○ interfaces:

- Operational state: interface ok, switched off, faulty
- Aggregate traffic statistics: # pkts/bytes in, out,...
- Use: obtain and manipulate operational state; sanity check (does link carry any traffic?); detect congestion

○ ip:

- Errors: ip header error, destination address not valid, destination unknown, fragmentation problems,...
- Forwarding tables, how was each route learned,...
- Use: detect routing and forwarding problems, e.g., excessive fwd errors due to bogus destination addresses; obtain forwarding tables

○ egp:

- Status information on BGP sessions
- Use: detect interdomain routing problems, e.g., session resets

Limitations

❑ Statistics hardcoded

- No local intelligence to: accumulate relevant information, alert NMS to prespecified conditions, etc.

❑ Highly aggregated traffic information

- Aggregate link statistics
- Cannot drill down

❑ Protocol: simple = dumb

- Cannot express complex queries over MIB information in SNMPv1
 - “Fet all or nothing”
 - More expressibility in SNMPv3: expression MIB

RMON1: Remote Monitoring

management
station

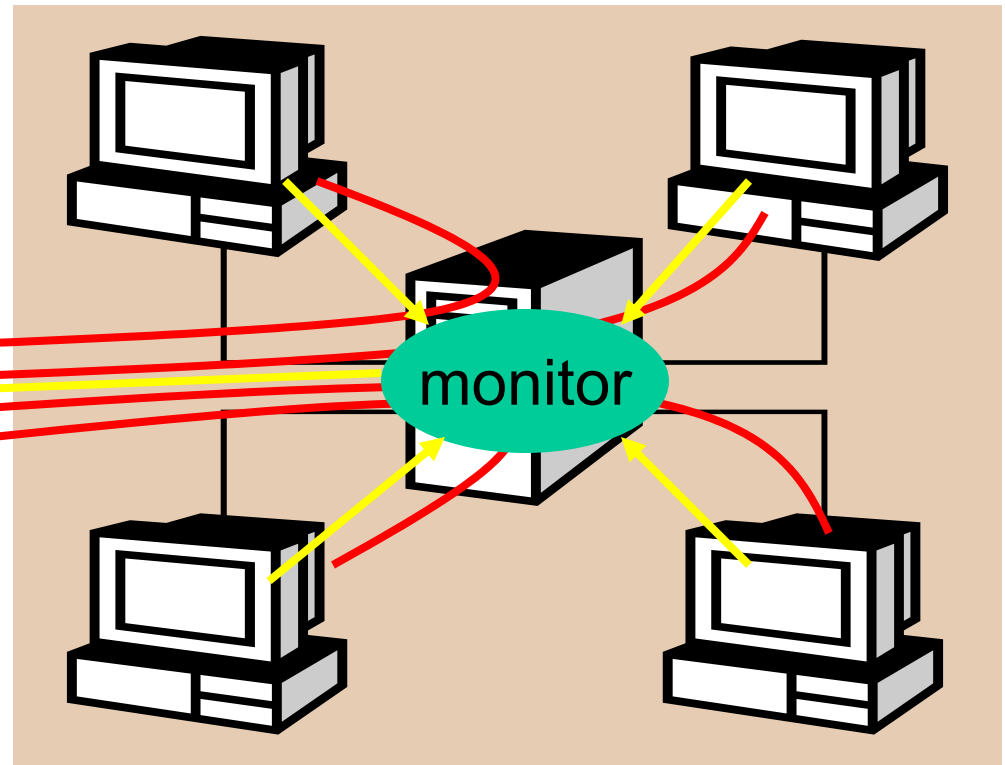
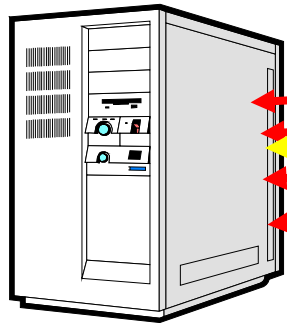

subnet

□ Advantages

- Local intelligence & memory
- Reduce management overhead
- Robustness to outages

Passive Measurement Capabilities: SNMP Statistics

- ❑ Available data:
 - Summary information from and about devices
- ❑ Possible analysis:
 - (User behavior)
 - Anomaly detection (intrusion detection system)
- ❑ Disadvantages:
 - Very coarse grain information
 - (Data flood)
 - Data aggregation
 - Needle in a haystack
 - Only captures on network device information

Passive Measurement Capabilities: SNMP Statistics (2.)

- Deployment scenarios:
 - Needs cooperation of the network operator
 - Data collection/aggregation infrastructure
- Challenges
 - Hard to see all
 - Data integrity
 - Level of detail – no connection to application
 - Data correlation
 - Data privacy vs. data sharing
 - Data collection across network confederations

Passive Measurement Capabilities: Routing Information

- Available data:
 - Summary information about devices

BGP Table Example (RouteViews)

```
* 199.222.69.0      167.142.3.6      0  5056 701 7046 i
*                   4.0.0.2          0   1 701 7046 i
*                   204.42.253.253   0  267 2914 701 7046 i
*                   212.4.193.253    0  8918 701 7046 i
*                   205.215.45.50    0  4006 701 7046 i
*                   193.140.0.1      0  8517 9000 2548 701 7046 i
*                   165.87.32.5      0  2685 701 7046 e
*                   206.220.240.223  0  10764 1 701 7046 i
*                   203.62.248.4     0  1221 16779 1 701 7046 i
*                   203.62.252.21    0  1221 16779 1 701 7046 i
*                   157.22.9.7       0   715 1 701 7046 i
*                   193.0.0.56       0  3333 9057 3356 701 7046 i
*                   195.219.96.239    0  8297 6453 701 7046 i
```

Prefix 199.222.69.0/24 has origin AS 7046
(whois says that 7046 is ASN-UUNET-CUSTOMER)

Passive Measurement Capabilities: Routing Information (2.)

- ❑ Available data:
 - Summary information about devices
- ❑ Possible analysis:
 - Network dynamics
 - Anomaly detection
 - Root cause analysis
- ❑ Disadvantages:
 - Very coarse grain information
 - (Data flood)
 - Data aggregation
 - Needle in a haystack
 - Only captures on network device information

Passive Measurement Capabilities: Routing Information (3.)

❑ Deployment scenarios:

- Collected anyhow by the network operator (currently basis for network management)
- Data collection/aggregation infrastructure

❑ Challenges

- Lack of detail
- Data integrity
- Data correlation
- (Data privacy vs. data sharing)
- (Data collection across network confederations)

Passive Measurement: Other

- ❑ Application protocol data
- ❑ Server related data
- ❑ Access networks
- ❑ Mobile networks
- ❑ Adhoc networks
- ❑ Sensor networks
- ❑ ...

Measurements: Summary

❑ Challenges:

- Scalability
 - How to reduce the amount of data to be analysed
- Data flood
 - What to measure when the purpose is unclear
 - Expect the unexpected
- Validation
 - How to verify any inference

❑ Importance:

- Enables network management
- Enables debugging
- Accountability
- Verifies presumed assumptions

Internet Dynamics: Time Scale

- Years: introduction of new protocols, e.g. IPv6
- Months: dimensioning a new circuit
- Weeks, days: different # of users responsible for weekly/daily cycle of traffic load
different application mix
- Hours: variability of traffic volume
- Seconds: retransmissions
- Subseconds: round trip times

Internet Control: Time Scale

- Years: IETF
- Months: network planning
- Weeks: network engineering
- Days: traffic engineering
- Hours: routing changes
- Seconds: TCP

Yet: User demand influences network performance
but is also influenced by network performance

Terminology And General Issues

- ❑ Measurements vs. metrics
- ❑ Measurement capabilities
- ❑ **Collection of measurement data**
- ❑ Data reduction techniques
- ❑ Clock issues

Collection Of Measurement Data

- ❑ Need to transport measurement data
 - Produced and consumed in different systems
 - Usual scenario: large number of measurement devices, small number of aggregation points (databases)
 - Usually in-band transport of measurement data
 - Low cost & complexity
- ❑ Reliable vs. unreliable transport
 - Reliable
 - Better data quality
 - Measurement device needs to maintain state and be addressable
 - Unreliable
 - Additional measurement uncertainty due to lost measurement data
 - Measurement device can “shoot-and-forget”

Terminology And General Issues

- ❑ Measurements vs. metrics
- ❑ Measurement capabilities
- ❑ Collection of measurement data
- ❑ **Data reduction techniques**
- ❑ Clock issues

Controlling Measurement Overhead

- Measurement overhead
 - In some areas, could measure everything
 - Information processing not the bottleneck
 - Examples: geology, stock market, ...
 - Networking: thinning is crucial!
- Three basic methods to reduce measurement traffic
 - Filtering
 - Aggregation
 - Sampling
 - ... and combinations thereof

Filtering

□ Examples:

○ Only record packets ...

- matching a destination prefix (to a certain customer)
- of a certain service class (e.g., expedited forwarding)
- violating an ACL (access control list)
- TCP SYN or RST packets (attacks, abandoned http download)

Aggregation

- Example: identify packet flows, i.e., sequence of packets close together in time between source-destination pairs [flow measurement]
 - Independent variable: source-destination
 - Metric of interest: total # pkts, total # bytes, max pkt size
 - Variables aggregated over: everything else

src	dest	# pkts	# bytes
a.b.c.d	m.n.o.p	374	85498
e.f.g.h	q.r.s.t	7	280
i.j.k.l	u.v.w.x	48	3465
....

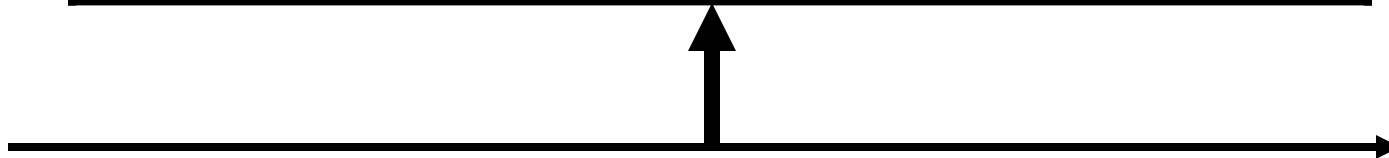

Aggregation (2.)

- Preemption: tradeoff space vs. capacity
 - Fix cache size
 - If a new aggregate (e.g., flow) arrives, preempt an existing aggregate
 - For example, least recently used (LRU)
 - Advantage: smaller cache
 - Disadvantage: more measurement traffic
 - Works well for processes with temporal locality
 - Because often, LRU aggregate will not be accessed in the future anyway → no penalty in preempting

Sampling

□ Examples

○ Systematic sampling

- Pick out every 100th packet and record entire packet/record header
- Ok only if no periodic component in process

○ Random sampling

- Flip a coin for every packet, sample with prob. $1/100$

○ Record a link load every n seconds

Sampling (2.)

- ❑ What can we infer from samples?
- ❑ Easy:
 - Metrics directly over variables of interest, e.g., mean, variance etc.
 - Confidence interval = “error bar”
 - Decreases as $1/\sqrt{n}$
- ❑ Hard:
 - Small probabilities:
“Number of SYN packets sent from A to B”
 - Events such as: “has X received any packets”?

Sampling (3.)

□ Hard:

- Metrics over sequences
- Example: “how often is a packet from X followed immediately by another packet from X?”
 - Higher-order events: probability of sampling i successive records is p^i
 - Would have to sample different events, e.g., flip coin, then record k packets

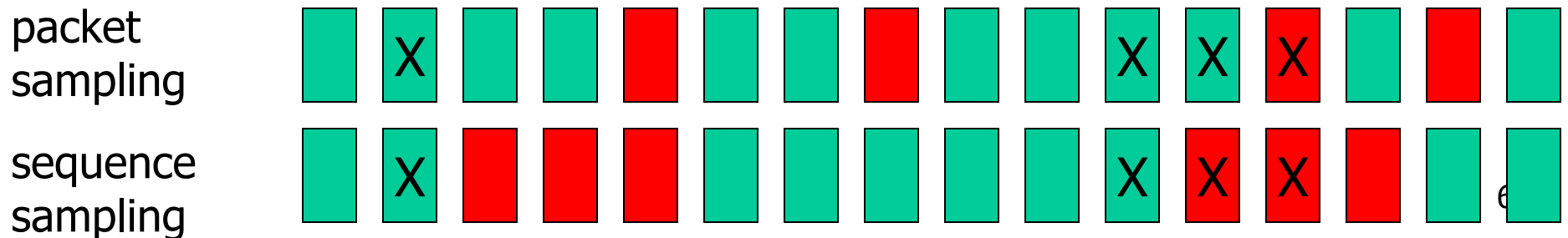

Sampling (4.)

- Sampling objects with different weights
- Example:
 - Weight = flow size
 - Estimate average flow size
 - Problem: a small number of large flows can contribute very significantly to the estimator
- Stratified sampling: make sampling probability depend on weight
 - Sample “per byte” rather than “per flow”
 - Try not to miss the “heavy hitters” (heavy-tailed size distribution!)

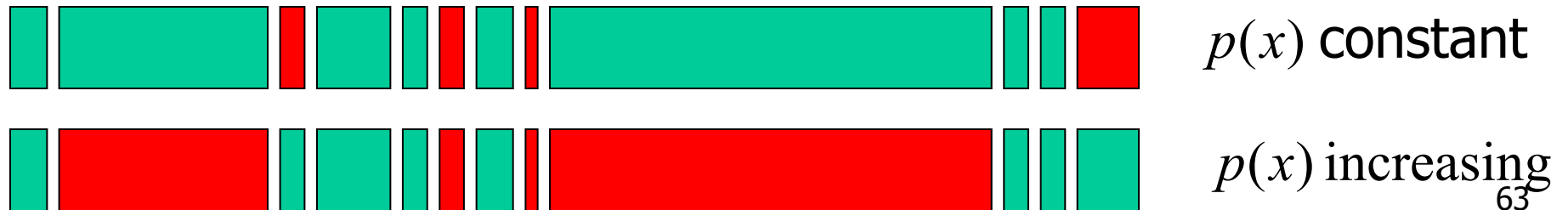

Sampling (5.)

Object size distribution

$n(x) = \#$ samples of size x

Estimated mean :

$$\hat{\mu} = \frac{1}{n} \sum_x x \cdot n(x)$$

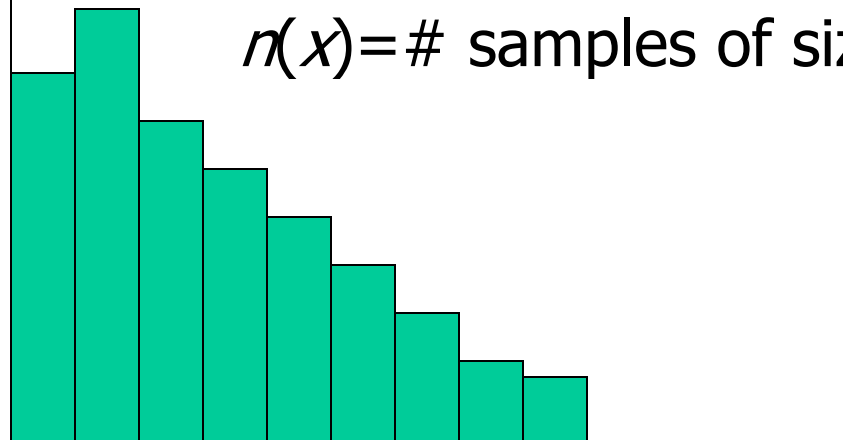

$x n(x)$: contribution to mean estimator

Variance mainly due to large x

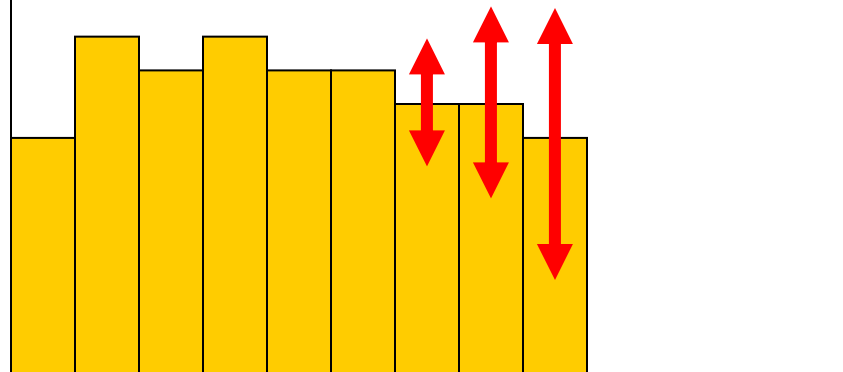

Better estimator: reduce variance by increasing # samples of large objects

Basic Properties

	Filtering	Aggregation	Sampling
Precision	exact	exact	approximate
Generality	constrained a-priori	constrained a-priori	general
Local Processing	filter criterion for every object	table update for every object	only sampling decision
Local memory	none	one bin per value of interest	none
Compression	depends on data	depends on data	controlled

Combinations

- ❑ In practice, rich set of combinations of filtering, aggregation, sampling
- ❑ Examples:
 - Filter traffic of a particular type, sample packets
 - Sample packets, then filter
 - Aggregate packets between different source-destination pairs, sample resulting records
 - When sampling a packet, sample also k packets immediately following it, aggregate some metric over these k packets
 - ... etc.

Terminology And General Issues

- ❑ Measurements vs. metrics
- ❑ Measurement capabilities
- ❑ Collection of measurement data
- ❑ Data reduction techniques
- ❑ **Clock issues**

Clock Issues

□ Time measurements

- Packet delays: we do not have a “chronograph” that can travel with the packet
 - Delays always measured as clock differences
- Timestamps: matching up different measurements
 - E.g., correlating alarms originating at different network elements

□ Clock model:

$$T(t) = T(t_0) + R(t_0)(t - t_0) + \frac{1}{2}D(t_0)(t - t_0)^2 + O((t - t_0)^3)$$

$T(t)$: clock value at time t

$R(t)$: clock skew : first derivative

$D(t)$: clock drift : second derivative

Delay Measurements: Single Clock

- Example: round-trip time (RTT)
- $T_1(t_1) - T_1(t_0)$
- only need clock to run approx. at the right speed

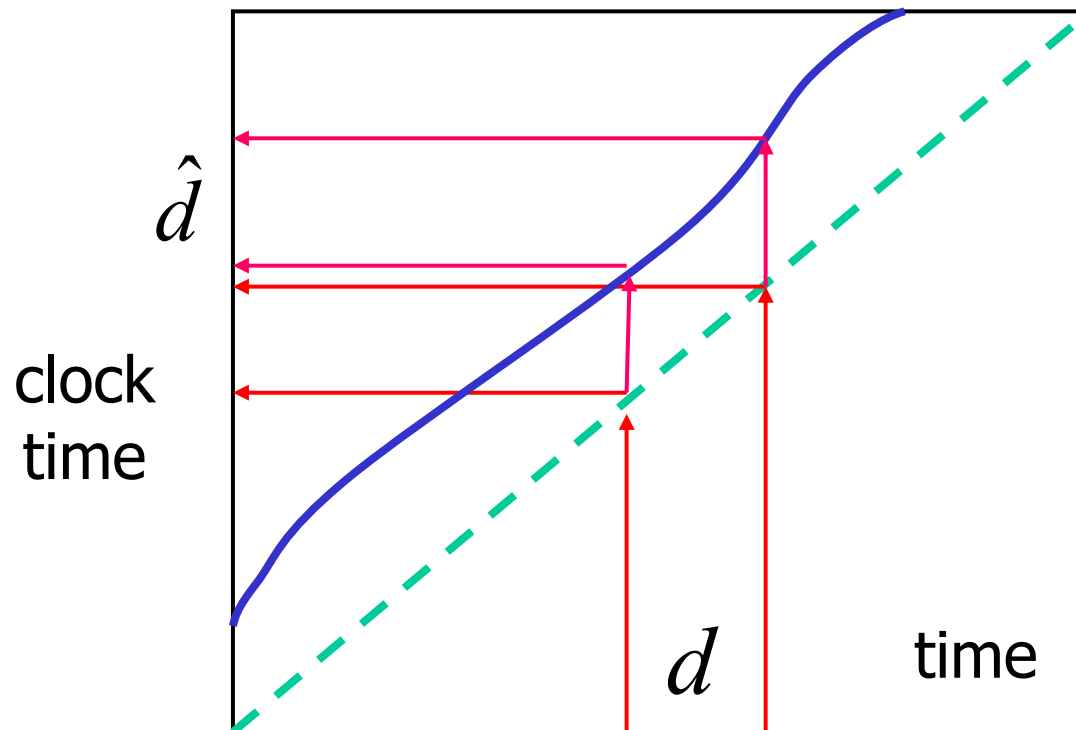

Delay Measurements: Two Clocks

- Example: one-way delay
- $T_2(t_1) - T_1(t_0)$
- very sensitive to clock skew and drift

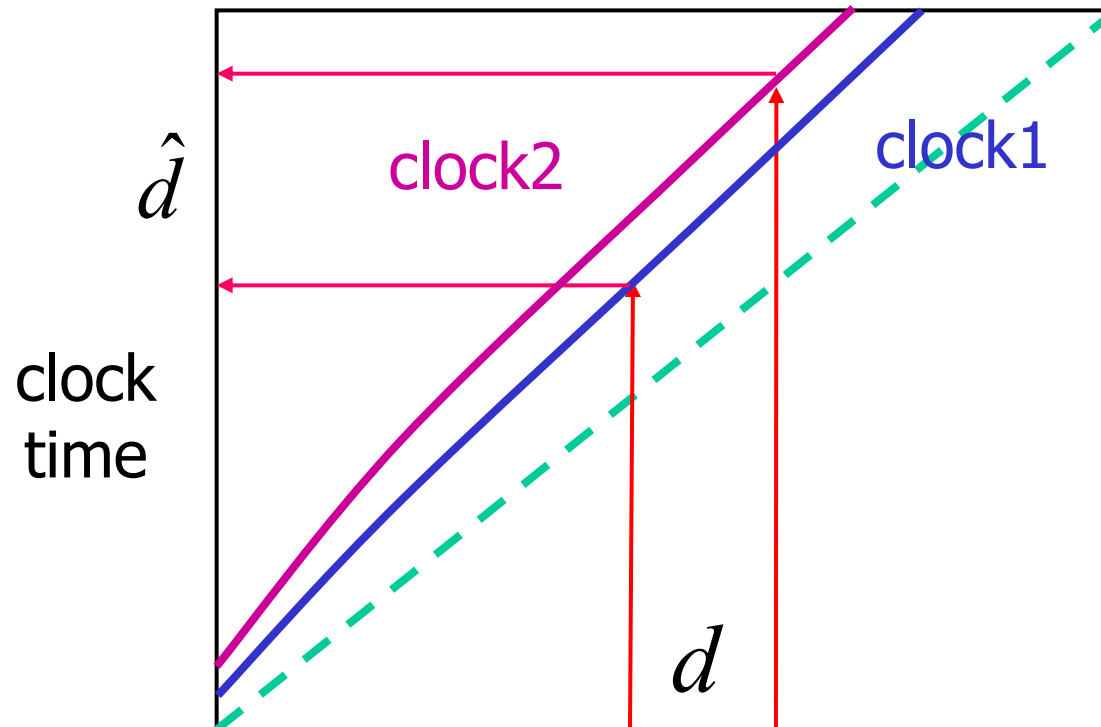

Clock Issues (2.)

□ Time-bases

- NTP (Network Time Protocol): distributed synchronization
 - No additional hardware needed
 - Not very precise and sensitive to network conditions
 - Clock adjustment in “jumps” → switch off before experiment!
- GPS
 - Very precise (100ns)
 - Requires outside antenna with visibility of several satellites
- SONET clocks
 - In principle available & very precise

NTP: Network Time Protocol

- ❑ Goal: disseminate time information through network
- ❑ Problems:
 - Network delay and delay jitter
 - Constrained outdegree of master clocks
- ❑ Solutions:
 - Use diverse network paths
 - Disseminate in a hierarchy (stratum $i \rightarrow$ stratum $i+1$)
 - A stratum- i peer combines measurements from stratum i and other stratum $i-1$ peers

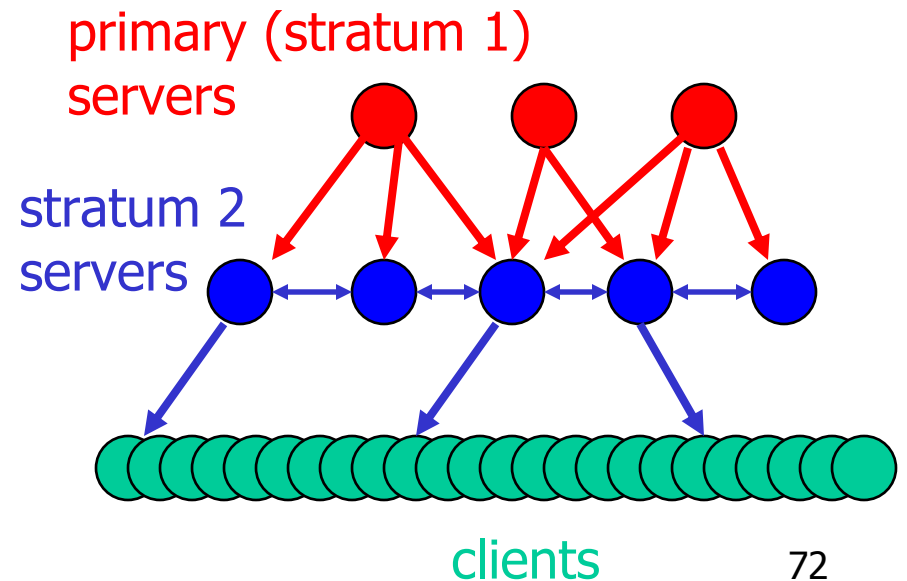
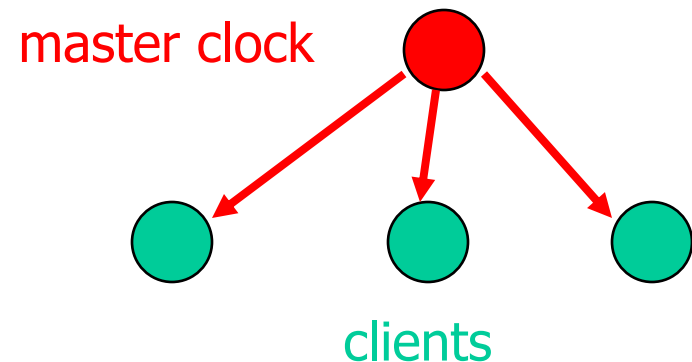

NTP: Peer Measurement

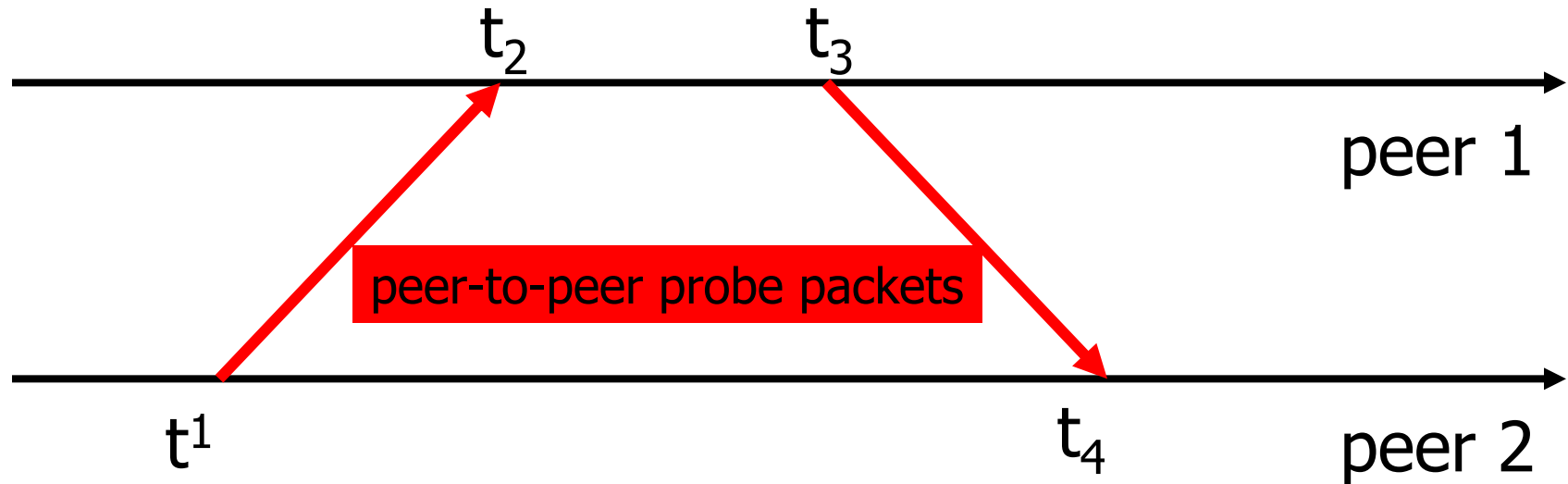

□ Message exchange between peers

- clock 2 knows $[T_2(t_1), T_1(t_2), T_1(t_3)]$ at t_4
- assuming $t_2 - t_1 \approx t_4 - t_3$,

$$\text{offset} \approx \frac{T_1(t_2) + T_1(t_3) - T_2(t_1) - T_2(t_4)}{2}$$

$$\text{roundtrip delay} \approx T_1(t_2) - T_1(t_3) - T_2(t_1) + T_2(t_4)$$

NTP: Combining Measurements

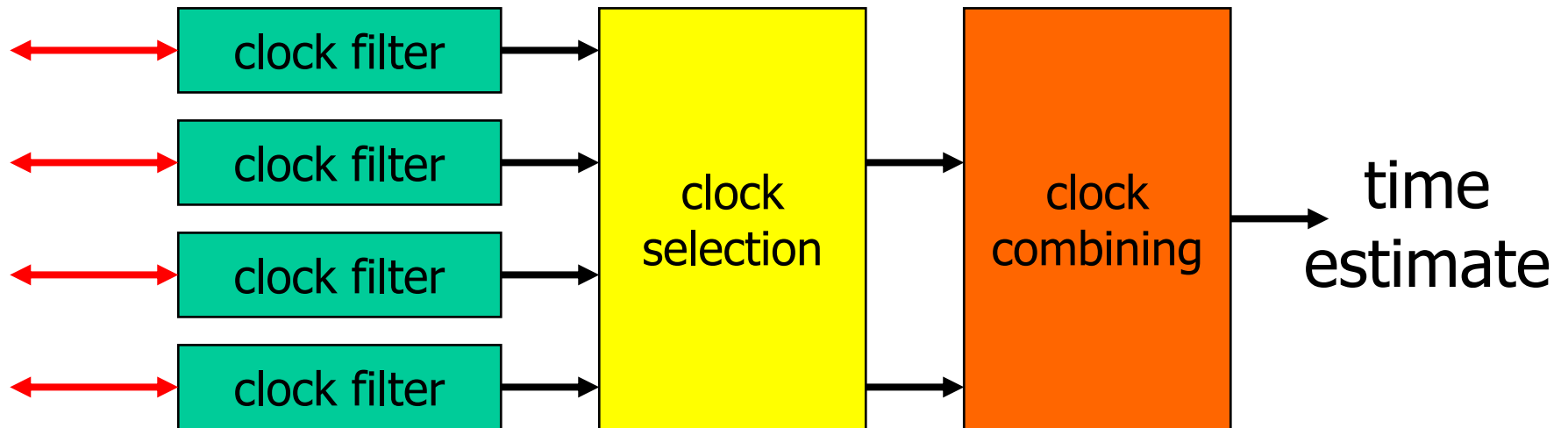

- ❑ Clock filter
 - Temporally smooth estimates from a given peer
- ❑ Clock selection
 - Select subset of "mutually agreeing" clocks
 - Intersection algorithm: eliminate outliers
 - Clustering: pick good estimates (low stratum, low jitter)
- ❑ Clock combining
 - Combine into a single estimate

NTP: Status And Limitations

- Widespread deployment
 - Supported in most OSs, routers
 - >100k peers
 - Public stratum 1 and 2 servers carefully controlled, fed by atomic clocks, GPS receivers, etc.
- Precision inherently limited by network
 - Random queueing delay, OS issues...
 - Asymmetric paths
 - Achievable precision: $O(20 \text{ ms})$